

## BLOCK TOOL-HALTER FÜR BOHRSTANGEN

mit Innenkühlung, für Reduzierhülsen geeignet

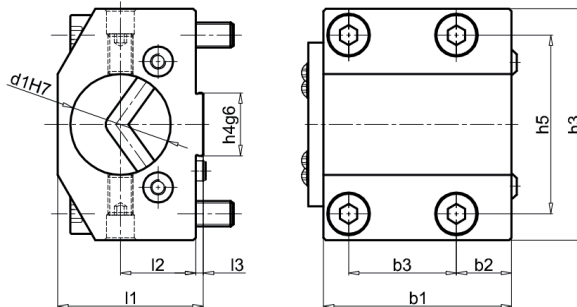
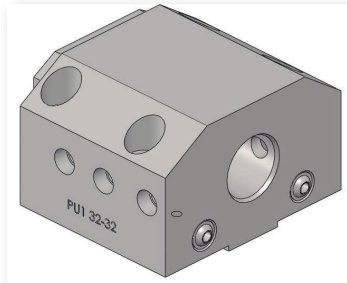

Art.-Nr.	Beschreibung Nutgröße x Bohrung	h4	d1	l2	h3	b1	h5	b2	b3	l1	l3	Preis
92PU1-2020	Block Tool-Halter 20 mm Nut x D 20 mm	20	20	25	74	60	57	17,5	34	48	3	160,00 €
92PU1-2025	Block Tool-Halter 20 mm Nut x D 25 mm	20	25	25	74	60	57	17,5	34	48	3	160,00 €
92PU1-2032	Block Tool-Halter 20 mm Nut x D 32 mm	20	32	25	74	60	57	17,5	34	48	3	160,00 €
92PU1-2040	Block Tool-Halter 20 mm Nut x D 40 mm	20	40	32	74	60	57	17,5	34	60	3	160,00 €
92PU1-2520	Block Tool-Halter 25 mm Nut x D 20 mm	25	20	30	92	75	71	22	43	58	3	175,00 €
92PU1-2525	Block Tool-Halter 25 mm Nut x D 25 mm	25	25	30	92	75	71	22	43	58	3	175,00 €
92PU1-2532	Block Tool-Halter 25 mm Nut x D 32 mm	25	32	30	92	75	71	22	43	58	3	175,00 €
92PU1-2540	Block Tool-Halter 25 mm Nut x D 40 mm	25	40	30	92	75	71	22	43	58	3	175,00 €
92PU1-2550	Block Tool-Halter 25 mm Nut x D 50 mm	25	50	38	92	75	71	22	43	73	3	175,00 €
92PU1-3225	Block Tool-Halter 32 mm Nut x D 25 mm	32	25	35	115	95	90	26	57	73	3	195,00 €
92PU1-3232	Block Tool-Halter 32 mm Nut x D 32mm	32	32	35	115	95	90	26	57	73	3	195,00 €
92PU1-3240	Block Tool-Halter 32 mm Nut x D 40 mm	32	40	35	115	95	90	26	57	73	3	195,00 €
92PU1-3250	Block Tool-Halter 32 mm Nut x D 50 mm	32	50	35	115	95	90	26	57	73	3	215,00 €
92PU1-3260	Block Tool-Halter 32 mm Nut x D 60 mm	32	60	40	115	95	90	26	57	83	3	235,00 €

**Nutgröße 25mm** für DMG MORI CTX450ECO, CTX510ECO, ecoTURN450, ecoTURN510, CTX beta 500/800/1250 linear mit VDI40, CLX450, CLX550

**Nutgröße 32mm** für DMG MORI CTX620, ecoTURN650, CTX beta 2000, CTX gamma 1250/2000/3000 mit VDI50

**Nutgröße 40mm** auf Anfrage

Ausführung ermöglicht uneingeschränkte Nutzung aller VDI-Stationen.  
Innenkühlung über Deckel gewährleistet

## BLOCK TOOL-HALTER FÜR VDI-AUFNAMEN

mit Kühlmittelübergabe

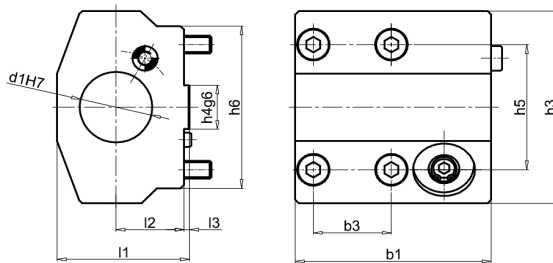
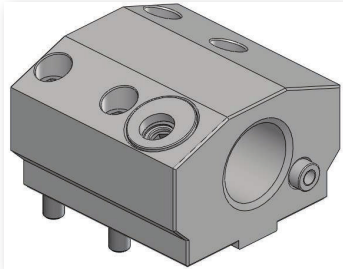

Art.-Nr.	Beschreibung Nutgröße x VDI	h4	d1	l2	h3	b1	h5	b3	l1	l3	h6	Preis
92PU3-2530	Block Tool-Halter 25 mm Nut x VDI 30	25	30	27,5	92	97	71	43	58	3	-	300,00 €
92PU3-2540	Block Tool-Halter 25 mm Nut x VDI 40	25	40	37,5	109	108	71	43	73	3	92	300,00 €
92PU3-3230	Block Tool-Halter 32 mm Nut x VDI 30	32	30	35	115	113	90	57	70	3	-	340,00 €
92PU3-3240	Block Tool-Halter 32 mm Nut x VDI 40	32	40	35	115	124	90	57	70	3	-	340,00 €
92PU3-3250	Block Tool-Halter 32 mm Nut x VDI 50	32	50	35	115	126	90	57	73	3	-	340,00 €

## BLOCK TOOL-HALTER FÜR BOHRSTANGEN

schwere, geschlitzte Ausführung, schwingungsdämpfend

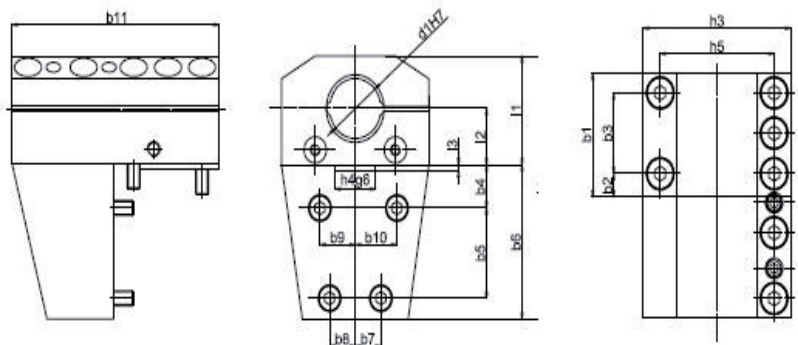
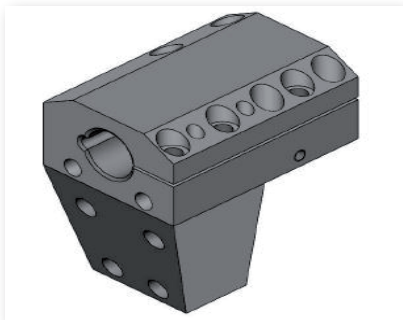

Art.-Nr.	Beschreibung Nutgröße x Bohrung	h4	d1	l2	h3	b11	h5	b1	b2	b3	l1	l3	l4	Preis
92PU1S-2540	Block Tool-Halter 25 mm Nut x D 40 mm	25	40	30	92	140	71	66	12,45	43	63	3	145	935,00 €
92PU1S-2550	Block Tool-Halter 25 mm Nut x D 50 mm	25	50	38	92	150	71	66	12,45	43	73	3	155	1.040,00 €
92PU1S-3240	Block Tool-Halter 32 mm Nut x D 40 mm	32	40	40	135	140	115	82	9,5	63	75	3	172	1.100,00 €
92PU1S-3250	Block Tool-Halter 32 mm Nut x D 50 mm	32	50	40	135	150	115	82	9,5	63	75	3	172	1.200,00 €
92PU1S-3260	Block Tool-Halter 32 mm Nut x D 60 mm	32	60	40	135	160	115	82	9,5	63	80	3	177	1.300,00 €
92PU1S-3280	Block Tool-Halter 32 mm Nut x D 80 mm	32	80	50	135	180	115	82	9,5	63	100	3	197	1.680,00 €

## REDUZIERHÜLSEN FÜR BLOCK TOOL-HALTER



Typ 1

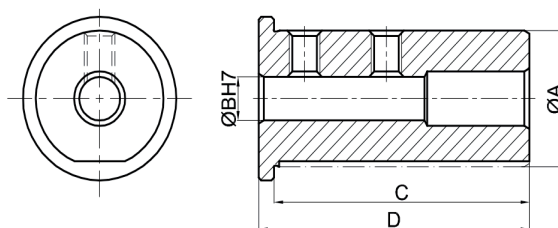

Typ 2

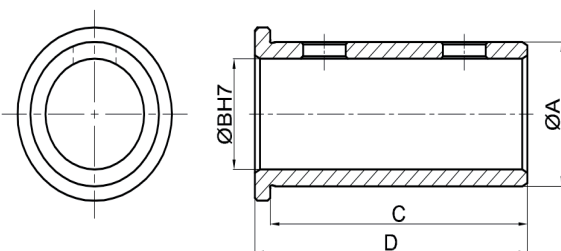

Art.-Nr.	Beschreibung	A	B	C	D	Typ	Halterausführung	Preis
93RHPU20-250661	Reduzierhülse 25 x 06 mm	25	06	58	61	1	PU1-2025	35,00 €
93RHPU20-250861	Reduzierhülse 25 x 08 mm	25	08	58	61	1		35,00 €
93RHPU20-251061	Reduzierhülse 25 x 10 mm	25	10	58	61	1		35,00 €
93RHPU20-251261	Reduzierhülse 25 x 12 mm	25	12	58	61	2		35,00 €
93RHPU20-251661	Reduzierhülse 25 x 16 mm	25	16	58	61	2		35,00 €
93RHPU20-252061	Reduzierhülse 25 x 20 mm	25	20	58	61	2		35,00 €
93RHPU20-320661	Reduzierhülse 32 x 06 mm	32	06	58	61	1	PU1-2032	38,00 €
93RHPU20-320861	Reduzierhülse 32 x 08 mm	32	08	58	61	1		38,00 €
93RHPU20-321061	Reduzierhülse 32 x 10 mm	32	10	58	61	1		38,00 €
93RHPU20-321261	Reduzierhülse 32 x 12 mm	32	12	58	61	1		38,00 €
93RHPU20-321661	Reduzierhülse 32 x 16 mm	32	16	58	61	2		38,00 €
93RHPU20-322061	Reduzierhülse 32 x 20 mm	32	20	58	61	2		38,00 €
93RHPU20-322561	Reduzierhülse 32 x 25 mm	32	25	58	61	2		38,00 €
93RHPU25-250676	Reduzierhülse 25 x 06 mm	25	06	73	76	1	PU1-2525	50,00 €
93RHPU25-250876	Reduzierhülse 25 x 08 mm	25	08	73	76	1		50,00 €
93RHPU25-251076	Reduzierhülse 25 x 10 mm	25	10	73	76	1		50,00 €
93RHPU25-251276	Reduzierhülse 25 x 12 mm	25	12	73	76	2		50,00 €
93RHPU25-251676	Reduzierhülse 25 x 16 mm	25	16	73	76	2		50,00 €
93RHPU25-252076	Reduzierhülse 25 x 20 mm	25	20	73	76	2		50,00 €
93RHPU25-320676	Reduzierhülse 32 x 06 mm	32	06	73	76	1	PU1-2532	55,00 €
93RHPU25-320876	Reduzierhülse 32 x 08 mm	32	08	73	76	1		55,00 €
93RHPU25-321076	Reduzierhülse 32 x 10 mm	32	10	73	76	1		55,00 €
93RHPU25-321276	Reduzierhülse 32 x 12 mm	32	12	73	76	1		55,00 €
93RHPU25-321676	Reduzierhülse 32 x 16 mm	32	16	73	76	2		55,00 €
93RHPU25-322076	Reduzierhülse 32 x 20 mm	32	20	73	76	2		55,00 €
93RHPU25-322576	Reduzierhülse 32 x 25 mm	32	25	73	76	2		55,00 €

## BLOCK TOOL-HALTER | Werkzeugaufnahmen für radiale Montage

Art.-Nr.	Beschreibung	A	B	C	D	Typ	Halteausführung	Preis
93RHPU25-400876	Reduzierhülse 40 x 08 mm	40	08	73	76	1	PU1-2540	60,00 €
93RHPU25-401076	Reduzierhülse 40 x 10 mm	40	10	73	76	1		60,00 €
93RHPU25-401276	Reduzierhülse 40 x 12 mm	40	12	73	76	1		60,00 €
93RHPU25-401676	Reduzierhülse 40 x 16 mm	40	16	73	76	1		60,00 €
93RHPU25-402076	Reduzierhülse 40 x 20 mm	40	20	73	76	1		60,00 €
93RHPU25-402576	Reduzierhülse 40 x 25 mm	40	25	73	76	2		60,00 €
93RHPU25-403276	Reduzierhülse 40 x 32 mm	40	32	73	76	2		60,00 €
93RHPU25-500876	Reduzierhülse 50 x 08 mm	50	08	73	76	1	PU1-2550	60,00 €
93RHPU25-501076	Reduzierhülse 50 x 10 mm	50	10	73	76	1		60,00 €
93RHPU25-501276	Reduzierhülse 50 x 12 mm	50	12	73	76	1		60,00 €
93RHPU25-501676	Reduzierhülse 50 x 16 mm	50	16	73	76	1		60,00 €
93RHPU25-502076	Reduzierhülse 50 x 20 mm	50	20	73	76	1		60,00 €
93RHPU25-502576	Reduzierhülse 50 x 25 mm	50	25	73	76	1		60,00 €
93RHPU25-503276	Reduzierhülse 50 x 32 mm	50	32	73	76	2		60,00 €
93RHPU25-504076	Reduzierhülse 50 x 40 mm	50	40	73	76	2		60,00 €
93RHPU32-250696	Reduzierhülse 25 x 06 mm	25	06	93	96	1	PU1-3225	50,00 €
93RHPU32-250896	Reduzierhülse 25 x 08 mm	25	08	93	96	1		50,00 €
93RHPU32-251096	Reduzierhülse 25 x 10 mm	25	10	93	96	1		50,00 €
93RHPU32-251296	Reduzierhülse 25 x 12 mm	25	12	93	96	2		50,00 €
93RHPU32-251696	Reduzierhülse 25 x 16 mm	25	16	93	96	2		50,00 €
93RHPU32-252096	Reduzierhülse 25 x 20 mm	25	20	93	96	2		50,00 €
93RHPU32-320696	Reduzierhülse 32 x 06 mm	32	06	93	96	1	PU1-3232	55,00 €
93RHPU32-320896	Reduzierhülse 32 x 08 mm	32	08	93	96	1		55,00 €
93RHPU32-321096	Reduzierhülse 32 x 10 mm	32	10	93	96	1		55,00 €
93RHPU32-321296	Reduzierhülse 32 x 12 mm	32	12	93	96	1		55,00 €
93RHPU32-321696	Reduzierhülse 32 x 16 mm	32	16	93	96	2		55,00 €
93RHPU32-322096	Reduzierhülse 32 x 20 mm	32	20	93	96	2		55,00 €
93RHPU32-322596	Reduzierhülse 32 x 25 mm	32	25	93	96	2		55,00 €
93RHPU32-400896	Reduzierhülse 40 x 08 mm	40	08	93	96	1	PU1-3240	55,00 €
93RHPU32-401096	Reduzierhülse 40 x 10 mm	40	10	93	96	1		55,00 €
93RHPU32-401296	Reduzierhülse 40 x 12 mm	40	12	93	96	1		55,00 €
93RHPU32-401696	Reduzierhülse 40 x 16 mm	40	16	93	96	1		55,00 €
93RHPU32-402096	Reduzierhülse 40 x 20 mm	40	20	93	96	1		55,00 €
93RHPU32-402596	Reduzierhülse 40 x 25 mm	40	25	93	96	2		55,00 €
93RHPU32-403296	Reduzierhülse 40 x 32 mm	40	32	93	96	2		55,00 €
93RHPU32-500896	Reduzierhülse 50 x 08 mm	50	08	93	96	1	PU1-3250	65,00 €
93RHPU32-501096	Reduzierhülse 50 x 10 mm	50	10	93	96	1		65,00 €
93RHPU32-501296	Reduzierhülse 50 x 12 mm	50	12	93	96	1		65,00 €
93RHPU32-501696	Reduzierhülse 50 x 16 mm	50	16	93	96	1		65,00 €
93RHPU32-502096	Reduzierhülse 50 x 20 mm	50	20	93	96	1		65,00 €
93RHPU32-502596	Reduzierhülse 50 x 25 mm	50	25	93	96	1		65,00 €
93RHPU32-503296	Reduzierhülse 50 x 32 mm	50	32	93	96	2		65,00 €
93RHPU32-504096	Reduzierhülse 50 x 40 mm	50	40	93	96	2		65,00 €

weitere Größen auf Anfrage